



Thanks to a continuous and regular flow, the water is distributed on a refrigerated surface designed to increase ice production. Three different sizes are available **FULL DICE, HALF DICE** and **LARGE DICE**

High production modular ice maker.
Up to 200kg production per 24/hr of dice cube.
Head only, stainless steel cabinet.
Complete with water & drain hoses.
10 AMP power supply.



ICE PRODUCTION

Air Cooled Unit

Air Temp.		Water Temperature			
		32°	21°	15°	10°
°C		32°	21°	15°	10°
°F		90°	70°	60°	50°
10°		198	218	222	225
50°		437	481	490	496
21°		177	197	201	204
70°		390	434	443	450
32°		140	160	164	167
90°		309	353	362	368
38°		122	142	146	149
100°		269	313	322	329

Water Cooled Unit

Air Temp.		Water Temperature			
		32°	21°	15°	10°
°C		32°	21°	15°	10°
°F		90°	70°	60°	50°
10°		173	193	202	205
50°		381	425	446	453
21°		161	183	194	197
70°		356	404	427	435
32°		158	176	184	190
90°		348	388	406	419
38°		145	165	175	183
100°		321	365	386	404

CUBE TYPE

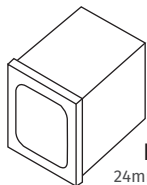

10g
FULL CUBE
24mm x 22mm x 22mm

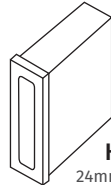

6g
HALF CUBE
24mm x 10mm x 29mm

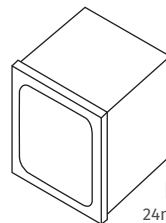

17g
LARGE CUBE
24mm x 29mm x 29mm

Solid ice cube, suitable for quick drink cooling, available in three different sizes, **FULL DICE (M models)**, **HALF DICE (MH models)** and **LARGE DICE (ML models)**, can be used in various applications: ice buckets, whisky on the rocks and cocktails.

CONTROL PANEL

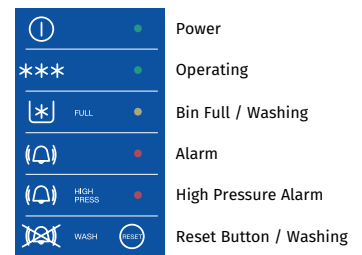

SUGGESTED STORAGE BIN



BH56
Stainless steel storage bin.
120kg capacity.

DIMENSIONS

W x D x H (mm)
560 x 620 x 660

OPERATING REQUIREMENTS

Rejected Heat	2432 W
Air Volume	590 m ³ /h















220-240/50/1



R404a GWP=3922

MIN		MAX
10°C (50°F)		40°C (104°F)
5°C (41°F)		35°C (95°F)
- 10 %		+ 10 %
1 Bar (14 psi)		5 Bar (70 psi)

SPECIFICATIONS

	 cond	 comp. W	 ABS. W	 Fuse	 kWh/100kg	 L / hr	 kg	 lbs	 kg	 lbs	 Ton CO2 equiv.
M192 A		2348	1100	16	14.7	11	68	150	80	176	3.14
M192 W		2348	1000	16	11.1	126	68	150	80	176	2.35

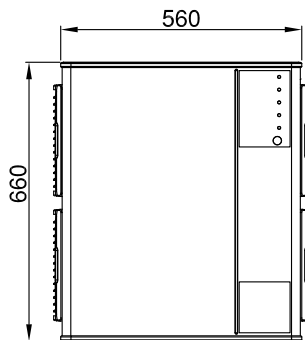

AIR COOLED

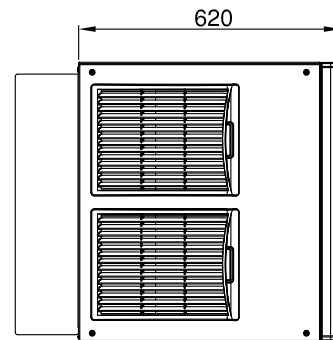

WATER COOLED

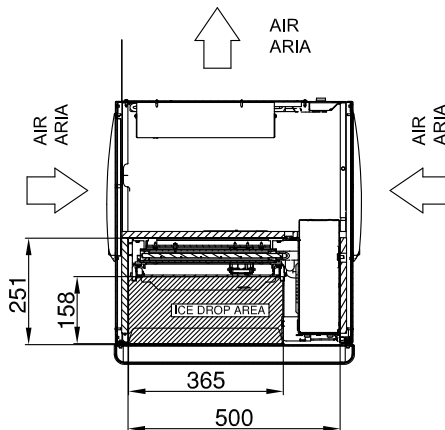
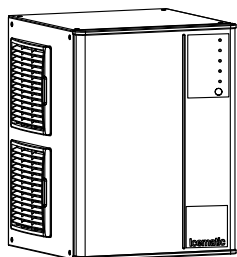
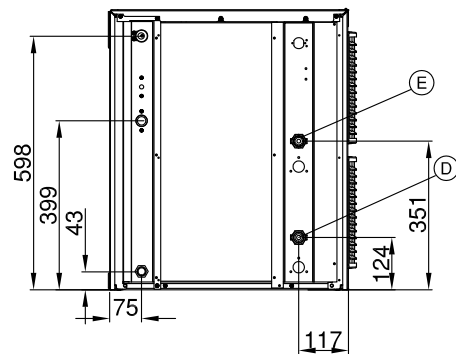
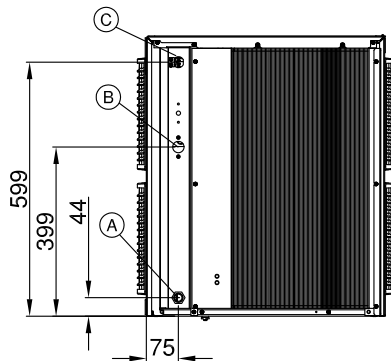

- (A)** Water drain 20mm diam.
- (B)** Potable water inlet 3/4" gas
- (C)** Electrical cable supply
- (D)** Water cooled inlet 3/4" gas
- (E)** Water cooled outlet 3/4" gas